

# Thermo Recorder



ThermoWorks

## TR-71U / TR-72U / TR-73U

Temperature / Humidity / Barometric Pressure Data Logger with USB Connection

For Measuring and Recording Temperature, Humidity and Pressure

Our compact lightweight TR-71U / 72U / 73U units allow you to effortlessly measure and record temperature in a range of -60 to 155°C, humidity from 10 to 95% and pressure from 750 to 1100 hPa. That data can then be transferred via high speed USB cable to your computer whereby our exclusive software empowers you to create colorful graphs and tables for saving or printing.



< PAT.P. >



**Easy to Use Software makes  
Graph and Table Creation a Snap.**

**T&D CORPORATION**

# Thermo Recorder

Data Logger USB Connection  
TR-71U / 72U / 73U

Easy USB Connection (Multiple Units OK) / Real-time Monitoring and Graph Display  
Adjustment Function Enabled Software / 1 Year Operation with only 1 AA Battery

## Measure / Record



## Download and Analyze



Connect



## 2 or more Measurement and Recording Channels in Each Unit

TR-71U has two temperature channels and TR-72U has one temperature and one humidity channel. TR-73U has a total of three channels: one temperature, one humidity, and one barometric pressure channel. The data recorded into the TR-71U/TR-72U units can then be downloaded quickly via USB cable to your computer whereby with our exclusive software you can easily process the data into graphs, tables, save to files and/or print it out. Moreover, it is possible to connect more than one unit at the same time.

## Wide Temperature Measuring Range -60°C to 155°C

The external sensor that comes with the TR-71U can measure and record from -40°C to 110°C, while optional sensors can give you a range of -60°C to 155°C. There is an array of optional external sensors to meet your every need.

## Humidity Measurement Range 10% to 95%RH

The two channel external sensor that comes with the TR-72U can measure and record temperature from 0 to 50°C and humidity from 10 to 95% RH.

## Pressure Measurement Range 750 to 1100hPa

The internal sensor that comes with the TR-73U can measure and record air pressure from 750 to 1100hPa.

## One Year Continual Use on One Battery

Using our specially designed low energy consumption circuit this unit can run on one AA Alkaline battery for up to one year of continued use. No need to worry about where you place it as the battery will allow you to measure and record over long periods of time no matter if the unit is in transit or in a distant place.

**Note:** Battery life will depend on the recording environment, recording interval, communication frequency, and ambient temperature. The above battery life test was carried out using a brand new battery and in no way do we guarantee a battery's life.

## Reliable Backup Function

We have eliminated the worry of losing data due to power loss or the switch being accidentally turned off.

### When Battery Power becomes Low

When battery power becomes low a battery life warning will appear on the unit's display indicating that the battery should be changed. If within a short time the battery is changed, measurement and recording will not be interrupted and there will be no data loss. If the battery is not changed the unit will automatically go into SLEEP mode whereby measurement and recording will stop but, due to our BACK UP FUNCTION, data will not be lost and will remain saved for up to one year.



### When the Switch is turned OFF

If while recording the power switch is accidentally turned OFF, data will not be lost but will be saved for up to one year from the time it was switched OFF.

**Note:** Even if the unit is in sleep mode it needs battery power. Hence, a total loss of battery power or removal of the battery will result in the loss of data.

## Accurate, Compact, Lightweight and Affordable

Our exclusive design and technology has allowed us to create a highly accurate yet compact and lightweight unit (55×78×18mm 62g) that is unbelievably affordable.

## Ready to Use - All in One Package

Everything you need to get started (main unit, sensor, battery, software, communication cable and user's manual) is included in this All in One Package. All you need to do is supply the computer.

## Large Data Capacity: 8,000 Readings x 2 Channels (TR-73U:8,000 x 3 Channels)

Each channel can record up to 8,000 readings; giving you about one year of continuous recording at a recording interval of 60 minutes.

## Easy to Read Multi-Functional Display

The easy to read LCD displays present temperature, recording condition, battery life warning, and unit of measurement.

### TR-71U / 72U

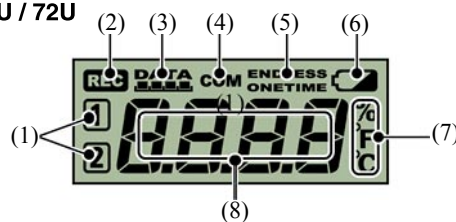

### TR-73U

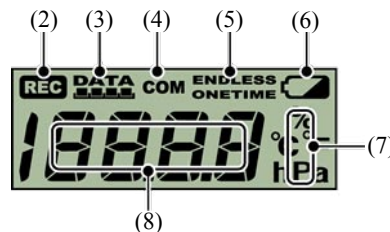

- (1) The channel number of the measurement being displayed will appear.
- (2) The recording condition will appear.  
ON: Recording in progress. BLINKING: Waiting for programmed start.
- (3) After every 2000 readings the scale will be marked from left to right.
- (4) This will appear when data is being sent or received.
- (5) ONETIME: When the number of recorded readings reaches 8000, "FULL" will appear in the unit's LCD display and recording will automatically stop. ENDLESS: When the number of recorded readings reaches 8000, the oldest data reading will be overwritten and recording will continue.
- (6) When the battery power becomes low, this will appear in the LCD display. If the battery power becomes even lower, SLP will appear and normal operations will stop. If the  signal appears, please change the battery as soon as possible.
- (7) The unit of measurement (°C, °F, %, hPa) for the display will appear.
- (8) Current measurements or operational messages such as FULL or SLP will appear.

# Standard Software

Easy to use Windows compatible software allows you to control all aspects of set up for any TR-71U/TR-72U/TR-73U unit, as well as to print, and to create text files, tables, and colorful graphs from the recorded data.

## Up to 8 Channels of Data can be Processed at One Time

By simply downloading the data from the main unit a colorful graph representing that data will be automatically created. Up to 8 channels (4 units) of data can be represented in one graph.

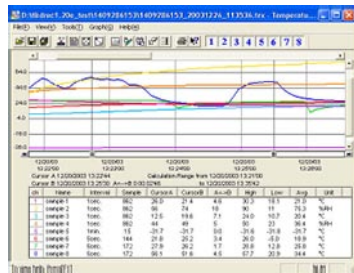

## Creating Text Files

You can create Text Files (CSV format, etc...) to allow you the option of processing and managing your data using Excel, Lotus or any other popular spreadsheet software.

## Optional

# T&D Recorder for Windows

## Adjustment Function

By setting adjustment values beforehand, you can record and display the post-adjusted measurement values. You can choose from two adjustment methods :

1-point and 2-point. Adjustment will be carried out using an adjustment equation of  $Y=aX+b$  : where X is the pre-adjusted measurement value and Y is the post-adjusted value.

## Current Readings Monitoring Display

With our exclusive software, you cannot only monitor the current measurements at a set interval, but can view those measurements in a continually changing graph. You can simultaneously display the current measurements and corresponding graphs for the number of units you have connected.

## Graph / Table Printing Function

You can print out in color or monochrome the graphs just as they appear on your screen. You can also print out in table form all of the data in order of date and time.

## TR-71U / 72U / 73U

### TR-1C30

**Sensor Extension Cable**  
Cable Length : 3m

Note: Only one cable per sensor. Can not be used with Temperature / Humidity sensor TR-3110 or TR-3100.

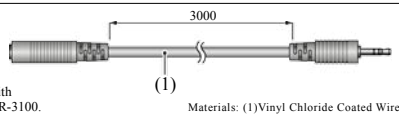

Materials: (1) Vinyl Chloride Coated Wire

### TR-5C10

**Sensor Extension Cable**  
Cable Length : 1m

Note: Only one cable per sensor. Can not be used with Temperature / Humidity sensor TR-3100.

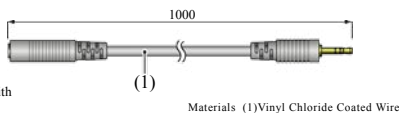

Materials: (1) Vinyl Chloride Coated Wire

### TR-07K2

**Wall Attachment**

Included :  
Wall Mount Screws × 2  
Double-Sided Adhesive Tape × 1

Material : ABS Resin

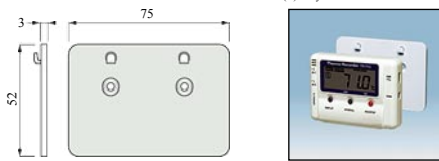

## TR-72U / 73U

### TR-3110

**Humidity and Temperature Sensor**  
Cable Length : 1m

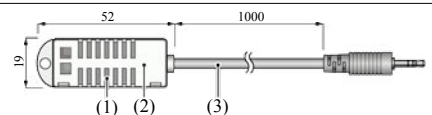

### TR-3100

**Humidity and Temperature Sensor**

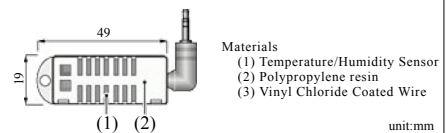

Materials  
(1) Temperature/Humidity Sensor  
(2) Polypropylene resin  
(3) Vinyl Chloride Coated Wire

unit:mm

Humidity Measurement Range : 10 to 95%RH  
Temperature Measurement Range : 0 to 50°C Sensor Durability Range:-10 to 55°C  
Humidity Measurement Accuracy : ±5%RH(at 25°C and 50%RH)  
Service Life : 1 year under normal conditions  
Operational Conditions : No Dew Condensation or Water Leakage / No contact with organic solvents, solutions or gasses emitted from spoiled food

## TR-71U / 72U

### TR-07C

**Serial Communication Cable**  
Cable Length : 1m

Note: For communication with computer.

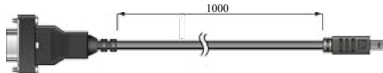

### TR-6C10

**Serial Communication Cable**  
Cable Length : 1m

Note: For communication with RTR-57U

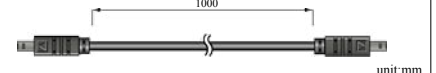

unit:mm

## Optional Sensors

## TR-71U

### TR-1106

**Teflon-Shielded Sensor**

Cable Length : 0.6m  
Thermal-Time Constant :  
In the Air Approx. 15 Sec.  
In agitated water : Approx. 2 Sec.

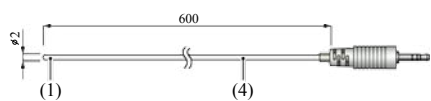

### TR-1220

**Stainless Protection Sensor**

Cable Length : 2m  
Thermal-Time Constant :  
In the Air : Approx. 36 Sec  
In agitated water : Approx. 7 Sec.

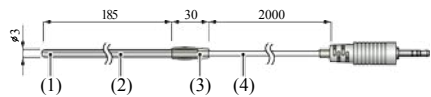

### TR-1320

**Stainless Protection Sensor**

Cable Length : 2m  
Thermal-Time Constant :  
In the Air : Approx. 12 Sec  
In agitated water : Approx. 2 Sec.

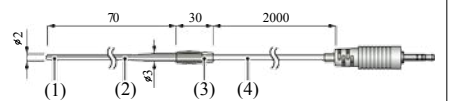

Materials: (1) Thermistor (2) Stainless Pipe (SUS316) (3) Teflon Compaction Tube (4) Teflon Resin(FEP) Shielded  
Possible Measurement Range : -60 to 155°C  
Sensor Temperature Durability : -70 to 180°C  
Water Resistant Ability : Splash Resistant  
Measurement accuracy : Average ±0.5°C(-40 to 80°C) Average ±1.0°C(-60 to -40/80 to 100°C)  
Average ±2.0°C(100 to 155°C)

## TR-71U / 72U / 73U

### TR-0106

**TPE resin-shielded sensor**

Cable Length : 0.6m  
Thermal-Time Constant :  
In the Air : Approx. 75 Sec.

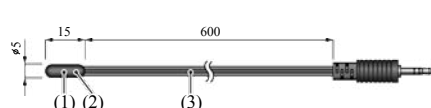

### TR-0306

**Stainless Protection Sensor**

Cable Length : 0.6m  
Thermal-Time Constant :  
In agitated water : Approx. 18 Sec.

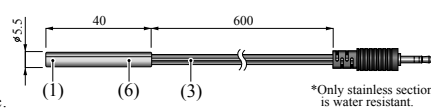

\*Only stainless section is water resistant.

### TR-0506

**Stainless Protection Sensor**

Cable Length : 0.6m  
Thermal-Time Constant :  
In agitated water : Approx. 20 Sec.

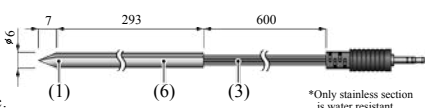

\*Only stainless section is water resistant.

### TR-0206

**Stainless Protection Sensor**

Cable Length : 0.6m  
Thermal-Time Constant :  
In the Air : Approx. 75 Sec

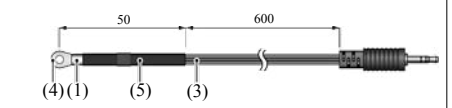

### TR-0406

**Stainless Protection Sensor**

Cable Length : 0.6m  
Thermal-Time Constant :  
In agitated water : Approx. 20 Sec.

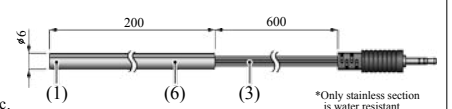

\*Only stainless section is water resistant.

### TR-0706

**Stainless Protection Sensor**

Cable Length : 0.6m  
Thermal-Time Constant :  
In agitated water : Approx. 18 Sec.

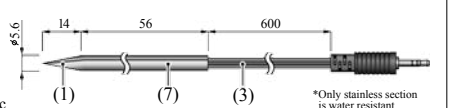

\*Only stainless section is water resistant.

Materials (1) Thermistor (2) TPE resin-shielded sensor (3) TPE resin-shielded wire (4) M3Screw Hole (5) Compaction Tube (6) Stainless Pipe(SUS304) (7) Stainless Pipe(SUS316)

unit:mm

Possible Measurement Range : -40 to 110°C Sensor Temperature Durability:-50 to 115°C  
Measurement Accuracy : Average ±0.3°C(-20 to 80°C) Average ±0.5°C(-40 to -20 / 80 to 110°C)

## Product Specifications

Unit	TR-71U	TR-72U	TR-73U
Measurement Channel	2 Channels (Select from Ch1. internal / Ch.2 external)	2 Channels (Temperature and Humidity)	3 Channels (Temperature, Humidity Barometric Pressure)
Measurement Item	Temperature	Temperature Humidity	Temperature Humidity Barometric Pressure
Internal Sensor	-10 to 60°C	-10 to 60°C	-10 to 60°C
External Sensor	-40 to 110°C	0 to 50°C	0 to 50°C
Optional Sensor	-60 to 155°C *1	-40 to 110°C	-40 to 110°C
Measurement Accuracy (Standard Sensor)	Average ±0.3°C (-20 to 80°C) Average±0.5°C (-40 to -20/80 to 110°C)	±5%RH (At 25°C 50%RH)	Average ±0.3°C (-20 to 80°C) Average±0.5°C (-40 to -20/ 80 to 110°C)
Measurement Resolution	0.1°C	1%RH	0.1°C 1%RH 0.1hPa
Sensor Materials	Thermistor	Macromolecular Humidity Sensor	Thermistor Macromolecular Humidity Sensor Macromolecular Humidity Sensor Barometric Pressure Sensor
Recording Interval	1, 2, 5, 10, 15, 20, 30 Seconds 1, 2, 5, 10, 15, 20, 30, 60 Minutes Total of 15 choices		
Recording Capacity	8,000 Readings × 2 Channels		8,000 Readings × 3 Channels
Recording Method	Endless Loop Method (Overwrite from the oldest data when recording capacity is full) One Time Method (Stop recording when recording capacity is full)		
LCD Display	Measurements (Ch1 only, Ch2 only, alternating display), Recording Status, Battery Life Warning, Amount of Recorded Data, Unit of Measurement	Measurements (Ch1 only, Ch2 only, Ch3 only, alternating display), Recording Status, Battery Life Warning, Amount of Recorded Data, Unit of Measurement	
Power	AA alkaline battery (LR6)		
Battery Life	About 1 year *2		About 10 month *2
Data Back-up	Activated when battery power is low or when switch is off (About 1 year)		
Interface	USB Communication Cable (option: RS-232C)		USB Communication Cable
USB Communication Time	When downloading (1 unit of full data - about 8 seconds)		When downloading (1 unit of full data - about 12 seconds)
Dimensions	H55mm × W78mm × D18mm		
Weight	About 62g (Including one AA battery)		
Attached Sensors	TR-0106 × 2 (TEP Resin-coated sensors)	TR-3100 × 1 (Temp. Humidity Sensor)	TR-3100 × 1 (Temp. Humidity Sensor)
Accessories	AA alkaline Battery (LR6) × 1 / User's Manual (Warranty) × 1		
Included in package	USB Cable × 1 (US-15C ; length 1.5m) Software Set × 1 / User's Manual (Warranty) × 1		

\*1: There are two types of temperature sensor for TR-71U depending on measurement range.

\*2: Battery life depends upon the measuring environment, recording interval, and quality of the battery being used.

## System Setup

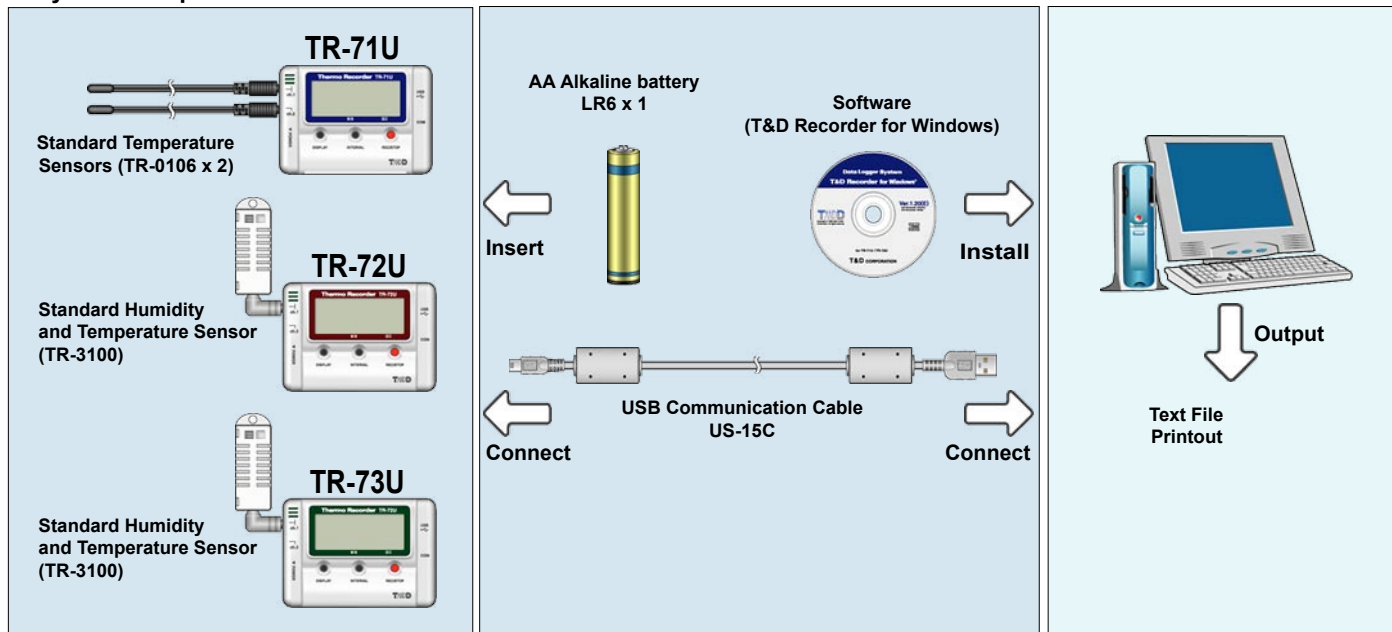

**Caution regarding safety** To ensure safe operation, carefully read instructions before using this unit.

## Software Specifications

Software	T&D Recorder for Windows
Compatible Devices	TR-71U, TR-72U, TR-73U
Communication Functions	Recording Start (Programmed Start / Immediate Start), Recording Stop Main Unit Settings (Recording Interval, Recording Method, Upper and Lower Limits) Downloading of Recorded Data
Temp/Humidity Graph Graph Display	Temperature, Humidity and Barometric Pressure Graphs for each Channel Zoom in, out and scroll with mouse or keyboard Change Channel Colors, Turn ON and OFF Channel Display
Data Display	Channel Name, Recording Interval, Number of Readings Highest, Lowest and Average Readings, Unit of Measurement. AB Cursor Dates, Times and Data Readings Calculated Difference between Cursor A and B
Number of Channels	8 Channel Simultaneous Display and Processing Possible to process mixed data from TR-71U, TR-72U and TR-73U units. (up to 4 units.)
Others	Data List Display, Calculation Range Settings, Data Maintenance Edit Recording Conditions, Delete Data by Channel Re-order Data by Channel
File Output	T&D Common Data File, Text File (CSV, etc)
Printing	(Selected Range or File for Entire Period) Graphs / Tables
Compatible OS	Microsoft Windows 2000 / XP English Microsoft Windows 98 / Me English Microsoft WindowsNT 4.0 English *1
PC/CPU	IBM Compatible with higher than Pentium 90MHz USB Port (1.0 / 1.1)
Memory	More than 16MB
Hard Disk	More than 4 MB of free space (Data will need more space)
Monitor	VGA (640 × 480) more than 256 colors

\*1: USB communication with TR-71U / 72U / 73U data loggers cannot be carried out using WindowsNT4.0.

Colors in the photos in this catalog may be different from real product colors. The specification and designs of the products in this catalog are true as of February 2004. Specifications are subject to change without notice. Microsoft, Windows and Excel are registered trademarks of Microsoft Corporation USA and other countries. Company names and product names are trademarks or registered trademarks of each company. Teflon is a registered trademark of the Dupont Corporation and of the Mitsui Dupont Fluoro-chemical Corporations. Lotus is a registered trademark of the Lotus Development Corporation. Pentium is a registered trademark of the Intel America Corporation.